



The all-digital Fiberlink® 7820 series has three modes of operation allowing the user to transmit high-quality HD/SD Component Video along with stereo audio, or S-Video and Composite Video along with stereo audio, or three channels of Composite Video along with stereo audio, all over a single fiber.

## Fiberlink® 7820 Series

**HD/SD Component, S-Video or Composite Video  
with stereo audio over single mode or multimode fiber.**



**World Headquarters**

5B Lyberty Way  
Westford MA 01886 USA  
Tel: (978) 263-5775  
Fax: (978) 263-9755  
info@artel.com

**artel.com**

## Contents

Welcome .....	3
Features .....	3
Package Contents .....	3
Technical Specifications	
Model Part Number Specifications .....	4
General Specifications .....	4
Video Specifications .....	4
Audio Specifications .....	5
Operating Loss Budgets .....	6
Maximum Useable Distance .....	6
Alarm Switch Settings .....	6
Installation Instructions .....	7
Video & Audio Configuration (Transmitter) .....	8
Video & Audio Configuration (Receiver) .....	9
Audio Wiring .....	10
Indicator LEDs .....	11
Operating Pointers .....	12
Troubleshooting .....	12
Maintenance and Repairs .....	13
Certifications .....	13
Warranty .....	14
Accessories and Related Products .....	15

## Welcome

Thank you for purchasing Artel Video Systems' Fiberlink® 7820 Series.

The Fiberlink® 7820 series has three modes of operation allowing the user to transmit high-quality HD/SD Component Video along with stereo audio, or S-Video and Composite Video along with stereo audio, or three channels of Composite Video along with stereo audio, all over a single fiber. The Fiberlink 7820 series is compatible with single mode or multimode fiber. The system utilizes all digital processing to deliver noise-free transmission. The 7820 series is a cinche to install with no equalization, deskewing or special tools required.

## Features

- Three modes of video operation: HD/SD Component, S-Video or three channels of Composite Video
- 30 MHz Component Video bandwidth
- 15 MHz Composite and S-Video bandwidth per channel
- Supports 1080i and 720p Component Video
- Video channel is compatible with NTSC, PAL or SECAM video standards
- Two audio channels that may be user-configured for balanced or unbalanced inputs and outputs
- Switch selectable audio output gain boost of +0 dB or +6 dB
- Indicator LEDs monitor power, video and audio signals
- Transmits over one multimode or single mode fiber
- No adjustments; pure digital processing and transmission
- Wide range power supply allows operation from both AC and DC sources
- System consists of transmitter and receiver unit; card or box version.
- Card version fills two slots in 6000A card cage

## Package Contents

- One Fiberlink® 7820 or 7821
- This User's Manual

## Technical Specifications

### Model Part Number Specification

Unit Type	Part Number
Transmitter Box	7820-B7S
Transmitter Rack Card	7820-C7S
Receiver Box	7821-B7S
Receiver Rack Card	7821-C7S

### General Specifications

Indicators	Power, Video, Audio, Alarm (Card version)
Box Version Dimensions	6.5 W x 1.15 H x 8 L (inches) 165 W x 29 H x 203 L (mm)
Weight	1 lb. (0.455 kg)
Number of slots in 6000A card cage	2
Power	9-24 volts AC or DC, TX: 4.5 Watts; 15.39 BTU/Hr RX: 4.0 Watts; 13.68 BTU/Hr
Operating Temperature	-10° to +60° C
Operating Wavelength	1310nm
Optical Connector	ST

### Video Specifications

Frequency Response	
Composite & S-Video:	15 MHz (-3 dB)
Component Video:	Y: 30 MHz (-3dB) PrPb: 15 MHz (-3dB)
Input/Output Impedance	75 Ohms, nominal
Signal-to-Noise Ratio	60 dB (CCIR weighted)
Differential Gain	0.7%
Differential Phase	0.5°
Y/C Delay	< 5 ns
2T K-Factor	0.5%

## Technical Specifications

### Video Specifications (cont.)

System Gain	Unity Gain, $\pm 3\%$
Video Connector	BNC; 4-Pin Mini-DIN for S-Video

### Audio Specifications

Number of Audio Channels	2, balanced or unbalanced
Bits per sample/ Sampling Rate	24 bits, 64 kHz
Audio Connector	Screw terminal block
Switches	<ul style="list-style-type: none"> <li>• Select input termination</li> <li>• Balanced or unbalanced input/output, selectable on a per-channel basis</li> <li>• Output gain boost +0 dB or +6 dB</li> </ul>
Frequency Response	+0/-0.5 dB, 20 Hz - 20 kHz
Maximum Audio Level	+10 dBu
Signal-to-Noise Ratio (A-weighted)	95 dB referenced full scale (balanced)
THD	0.002%, 20Hz - 20 kHz, full scale
Channel Phase Differential	$\pm 0.1^\circ$
Crosstalk	-100 dB (1kHz)
Audio Noise Level	-85 dBm
System Gain	Unity Gain, $\pm 3\%$ , input: balanced 600 ohms, 50 ohms source impedance ; output: balanced into 600 ohms, gain boost 0 dB.
Receiver Output Gain	+0 dB or +6 dB; switch selectable
Input Impedance	600 Ohms terminated, >24K ohms unterminated
Output Impedance	50 Ohms nominal
Audio to Video Diff. Delay (skew)	<300 usec

## Optical Loss Budget & Maximum Useable Distance

Fiber Type	Loss Budget	Distance
Single Mode Fiber	0-17 dB	40km
Multimode Fiber (62.5u)	0-17 dB	1.0km
Multimode Fiber (50u)	0-17 dB	1.3km

\*Distance specifications are approximate and are not guaranteed.  
Operating loss budget must not be exceeded.

## Alarm Switch Settings & Options

The Rack Card version of this product has an additional red indicator LED that illuminates when an alarm condition exists.

The rack card unit also provides an output to drive a model 6020A Alarm Sensing Module which provides an audible tone and activates a set of contacts for external signaling purposes.

## Alarm Switch Settings for the Transmitter Card

Switch Position	Alarm Indication	On	Off
1 (Channel A)	Loss of Input Video	Enabled	Disabled
2 (Channel B)	Loss of Input Video	Enabled	Disabled
3 (Channel C)	Loss of Input Video	Enabled	Disabled
4	N/A	N/A	N/A

## Alarm Switch Settings for the Receiver Card

Switch Position	Alarm Indication	On	Off
1 (Channel A)	Loss of Input Video	Enabled	Disabled
2 (Channel B)	Loss of Input Video	Enabled	Disabled
3 (Channel C)	Loss of Input Video	Enabled	Disabled
4	Loss of Optical Signal	Enabled	Disabled

## Installation Instructions

The Fiberlink® 7820 Series of fiber optic transmission systems are ready for immediate use and do not require any special tools or equipment. However, an Optical Power Meter, such as the Fiberlink® 6615, can be useful in determining optical loss budgets during your systems design and maintenance.

### The following instructions describe the typical installation procedure:

- 1) Connect the video source to the video input (BNC or S-Video) on the transmitter unit.
- 2) (Optional) Connect your audio source to the audio input on the transmitter unit.
- 3) Connect the video output cable to the video output (BNC or S-Video) connector on the receiver unit.
- 4) (Optional) Connect audio output cable to the audio output on the receiver unit.
- 6) Connect the fiber optic cable to the transmitter and receiver units.
- 7) Configure your video preferences as described in the Video & Audio Configuration section of this manual.
- 8) Configure your audio preferences as described in the Video & Audio Configuration section of this manual.
- 9) Connect the Universal Power Supply to the transmitter and receiver units.  
For box versions using DC power, please refer to figure 1.
- 10) When power is applied, the green POWER LED should illuminate, indicating the presence of operating power. The Video and the Audio LEDs will give an indication as described in the Indicator LED's and Alarm Circuitry section of this manual.

**Note: The Fiberlink 7820 does not cross convert. For example, if you input S-Video on the transmitter, only S-Video will be available on the receiver.**

*Note: The Rack Card version has an additional red LED for indicating the presence of an alarm condition (loss of signal). Refer to Indicator LED's and Alarm Circuitry sections of this manual.*

**Figure 1:  
Power Connector  
DC Input Polarity**

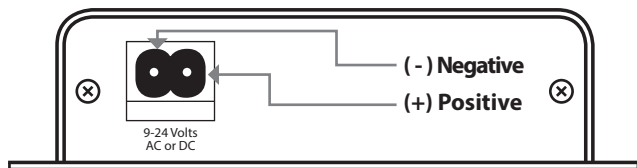









The transmitting element in the Fiberlink® 7820 transmitter unit contains a solid state Laser Diode located in the optical connector. This device emits invisible infrared electromagnetic radiation which can be harmful to human eyes. The radiation from this optical connector, if viewed at close range with no fiber optic cable connected to the optical connector, may be sufficient intensity to cause instantaneous damage to the retina of the eye. Direct viewing of this radiation should be avoided at all times!

**DANGER!**







### Video & Audio Configuration (Transmitter):

The Fiberlink 7820 Transmitter units have a six position DIP switch that is accessible from the front panel. Operation is as follows:

**Video & Audio Configuration Switch Settings (Transmitter Box)**

	3x Composite	SVid/Composite	HD Component
<b>Video</b> Switch 1 & 2			
	Note: Composite Video available on Channel A		
	Balanced (600Ω)	Balanced (24k)	Unbalanced (24k)
<b>Audio Ch 1:</b> Switch 5 & 6			
<b>Audio Ch 2:</b> Switch 3 & 4			

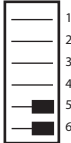
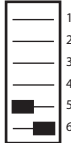
**Video & Audio Configuration Switch Settings (Transmitter Card)**

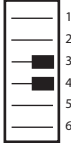
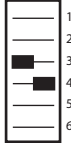
	3x Composite	SVid/Composite	HD Component
<b>Video</b> Switch 1 & 2			
	Balanced (600Ω)	Balanced (24k)	Unbalanced (24k)
<b>Audio Ch 1:</b> Switch 5 & 6			
<b>Audio Ch 2:</b> Switch 3 & 4			



### Audio Configuration (Receiver):

The Fiberlink 7821 Receiver units have a six position DIP switch that is accessible from the front panel. Switches 1 & 2 are not used. Operation is as follows:

Audio Configuration Switch Settings (Receiver Box)				
Channel	Balanced	Unbalanced	Boost	No Boost
<b>Audio Ch 1:</b> Switch 4 & 6				
<b>Audio Ch 2:</b> Switch 3 & 5				
Audio Configuration Switch Settings (Receiver Card)				
Channel	Balanced	Unbalanced	Boost	No Boost
<b>Audio Ch 1:</b> Switch 4 & 6				
<b>Audio Ch 2:</b> Switch 3 & 5				

***There is no need to configure video settings on the 7821 receiver as the Fiberlink 7820 series does not cross convert video formats. The 7821 receiver will automatically detect the video type and make the correct baseband outputs active.***

### Audio Wiring - Transmitter

#### Balanced

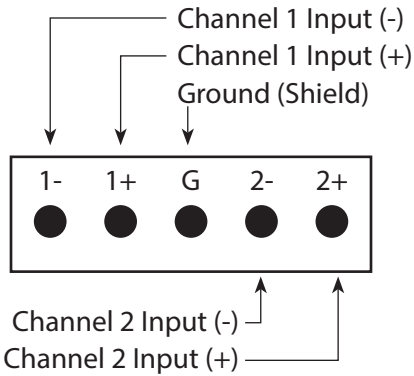

#### Unbalanced

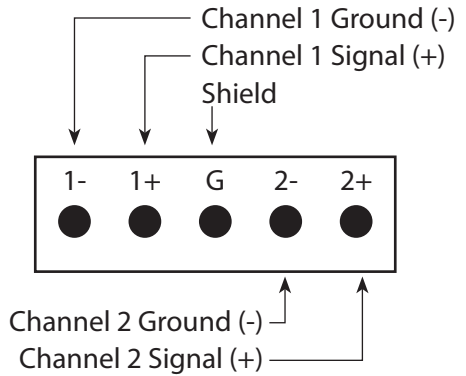

### Audio Wiring - Receiver

#### Balanced

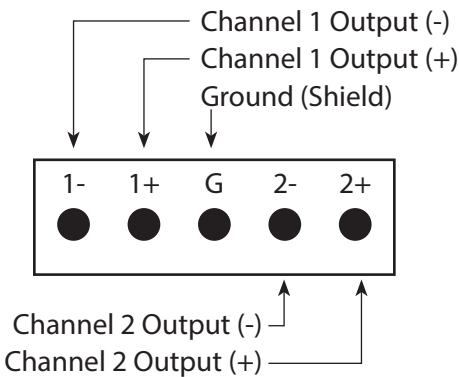

#### Unbalanced

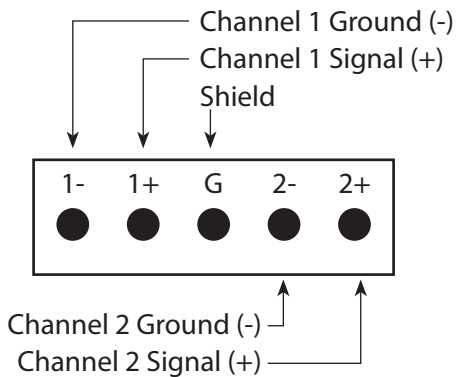

## Indicator LEDs

The Fiberlink® 7820 Series has several indicator LEDs that are used to monitor the state of the unit. Card versions have an additional Alarm LED.

LEDs		
LED	Status	Definition
Power	On	Indicates that correct power has been applied.
Video A	Off	Indicates that no video is present
	On	Indicates that video is present
Video B	Off	Indicates that no video is present
	On	Indicates that video is present
Video C	Off	Indicates that no video is present
	On	Indicates that video is present
Audio	Off	Indicates that no audio is present
	Blinking	Indicates that audio is present
Alarm	On	Error condition as described in the Alarm Switch Settings section of this manual

## Operating Pointers

Remember to check attenuation of the fiber optic cable. The system will only operate properly if these specifications fall within the range of the system's loss budget.

## Troubleshooting

Multimode fiber optic cable contains an optical fiber with a light carrying "core" that is only .0025 inches (62.5 microns) in diameter. Single mode fiber optic cable has an even smaller "core," only .00032 to .0004 inches (8-10 microns). This is smaller than a human hair! Therefore, any minute particles of dirt or dust can easily block the fiber from accepting or radiating light. To prevent this from happening, always use the provided dust caps when ever optical connectors are exposed to air. It is also a good idea to gently clean the tip of an optical connector with a lint-free cloth moistened with alcohol whenever dust is suspected.

The status of the LEDs should provide the first clue as to the origin of any operational failure. If these are off, it usually means that the fiber is broken or has too much attenuation. Next, be certain that the input and output signal connections are correct.

An optical power meter, such as the Fiberlink® 6615, a visible light source, such as the Fiberlink® 6610, and a Three Wavelength Light Source, such as the Fiberlink® 6620, can greatly assist and expedite troubleshooting of fiber optic transmission systems and are recommended tools all installers should have available.

Finally, although multimode and single mode devices may look the same, they will not operate properly together. Using the wrong device or fiber can easily add more attenuation than specified, resulting in poor overall performance. It should be noted that some of our fiber optic products support both single mode and multimode fiber in the same unit.

If, after reviewing the above possibilities, the system is still not operating, please contact the Customer Service Department for further assistance. If you suspect your problem is caused by the optics or the fiber optic cable, and you have an optical power meter, please take the appropriate measurements prior to contacting support.

## Maintenance and Repairs

The Fiberlink® 7820 Series has been manufactured using the latest semiconductor devices and techniques that electronic technology has to offer. They have been designed for long, reliable and trouble-free service and are not normally field repairable.

Should difficulty be encountered, Artel Video Systems maintains a complete service facility to render accurate, timely and reliable service of all products.

The only maintenance that can be provided by the user is to ascertain that optical connectors are free of dust or dirt that could interfere with light transmission and that electrical connections are secure and accurate. Please see the Troubleshooting section of this manual for additional information.

An optical power meter, such as the Fiberlink® 6615, a visible light source, such as the Fiberlink® 6610, and a Three Wavelength Light Source, such as the Fiberlink® 6620, can greatly assist and expedite troubleshooting of fiber optic transmission systems and are recommended tools all installers should have available.

All other questions or comments should be directed to our Customer Service Department. It should be noted that many “problems” can easily be solved by a simple telephone call.

If you suspect your problem is caused by the optics or the fiber optic cable, and you have an optical power meter, please take the appropriate measurements prior to contacting support.

---

## Certifications





### Fiberlink® 6656 Visible Fault Locator

The Fiberlink 6656 is a light-weight, hand-held tool used to quickly troubleshoot faults in the continuity of both single-mode and multimode fibers. High-intensity visible laser allows for visible fault location of breaks and microbends in both single-mode and multimode fibers.



### Fiberlink® 6650 Optical Power Meter

The Fiberlink 6650 Optical Power Meter is a high accuracy, high resolution, microprocessor controlled optical power meter. 65 dB dynamic range; calibrated to measure 850, 1300, 1310 and 1550nm. Works with multimode and single mode fiber. Graphical LCD display with intuitive user interface with simple 2-key operation.



### Fiberlink® 6654 Dual Wavelength Single Mode Light Source

The Fiberlink® Light Source offers a laser output at selectable wavelengths, allowing for convenient, on-site testing of fiber networks during construction and maintenance procedures.





## Fiberlink® 7820 Series

**HD/SD Component, S-Video or Composite Video  
with stereo audio over single mode or multimode fiber.**



### **World Headquarters**

5B Lyberty Way  
Westford MA 01886 USA  
Tel: (978) 263-5775  
Fax: (978) 263-9755  
info@artel.com

### **artel.com**

©2015 Artel Video Systems  
All Rights Reserved.

Fiberlink and the starburst logo are  
registered trademarks of  
Artel Video Systems.

P/N CS200-128384-00\_I